

CONTROL UNIT 220-110 V AC

AZUD FBC 109T

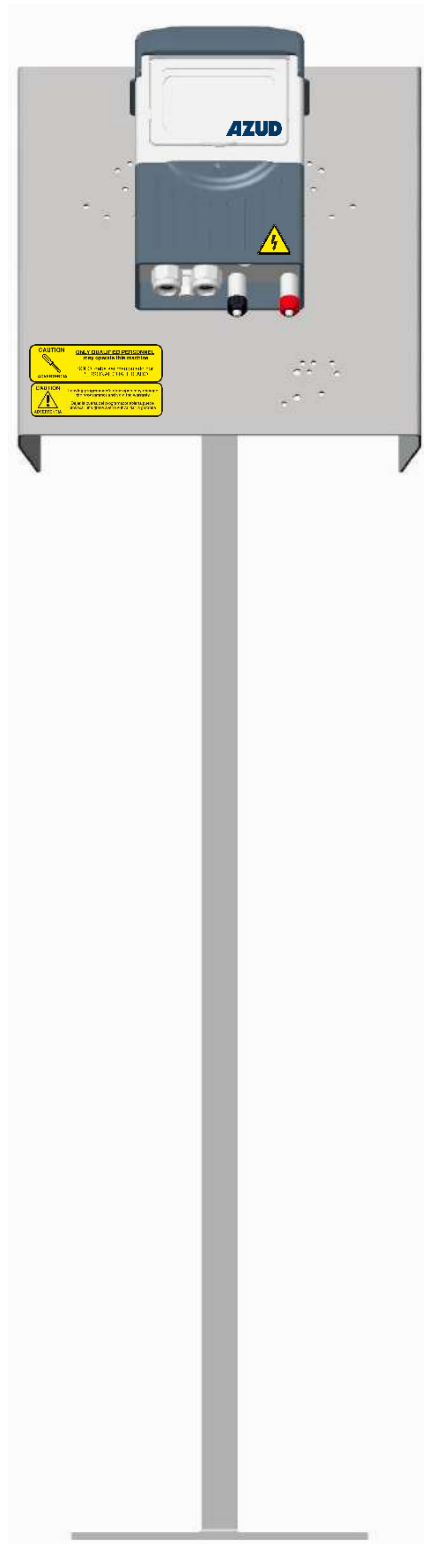

+ INFO





All information, illustrations and specifications in this catalogue are based on the latest information available at the time of publication, and shall not be construed as a commitment of AZUD.

AZUD may alter, remove or change the content of this document without any further notice, and shall not assume any responsibility for errors that may appear in this document. The Spanish version of this catalogue will prevail over the versions of the document that can be made in different languages.

System of symbols used in this manual:

In the reading of this manual you will find some signs used as information points to warn and to identify risks. This is the format and content of these messages:

| | |
|---|--|
|  | <i>The failure obeying these instructions and warnings could cause damage to people, the equipment and the surrounding area.</i> |
|  | <i>The failure to obeying these instructions and warnings could cause direct damages to people derived from an electric risk</i> |

This manual can be subject to modifications without previous notice.

TABLE OF CONTENTS

| | |
|--|----|
| 1. INTRODUCTION | 3 |
| 2. CHARACTERISTICS OF THE CONTROL UNIT | |
| 2.1 Introduction | 3 |
| 2.2 Identification of the product | 3 |
| 2.3 Technical Data of the Control Unit | 4 |
| 2.4 Types of activation and backflushing cycles | 4 |
| 2.5 Working description | 5 |
| 3. PROGRAMMING OF AZUD FBC CONTROL UNIT | |
| 3.1 Identify the controller firmware version | 6 |
| 3.2 Control Unit Site Map | 7 |
| 3.3 Change in reaction to the Pressostat | 8 |
| 3.4 Enable/Disable Sound | 8 |
| 3.5 Control Unit Information | 9 |
| 3.6 Programming of Control Unit | 9 |
| 3.7 Control Unit configuration | 10 |
| 3.8 Anticipation time of the sustaining valve | 11 |
| 3.9 Backflushing time of each station | 11 |
| 3.10 Time between stations | 11 |
| 3.11 Time between backflushings | 11 |
| 3.12 Delay of the Differential Pressure Gauge | 11 |
| 3.13 Number of stations of the Filtration Equipment | 12 |
| 3.14 Backflushing activating pressure differential | 12 |
| 3.15 Consecutive backflushing cycles number | 12 |
| 3.16 Activation alarms | 12 |
| 3.17 Automatic calibration | 12 |
| 3.18 Pressure measurement units | 12 |
| 4. AUXILIARY ELEMENTS | 13 |
| 4.1 How to activate backflushings by external signal | 13 |
| 4.2 How to connect an element which cancels temporally backflushes | 13 |
| 4.3 Anticipation signal. Sustaining Valve | 13 |
| 4.4 How to activate backflushes by real filtration time | 14 |
| 5. COMPONENTS AND SPARE PARTS | 15 |
| 6. SAFETY INFORMATION | 17 |
| 7. INSTALLATION INSTRUCTIONS | 18 |
| 7.1 Installation of the Control Unit's support | 18 |
| 7.2 Hydraulic connection between the CU and the filtration equipment | 18 |
| 8. ELECTRIC CIRCUITS | 19 |
| 9. MAINTENANCE INSTRUCTIONS | 26 |
| 10. POSSIBLE PROBLEMS – CAUSES – SOLUTIONS | 27 |
| 11. WARRANTY | 30 |

1. Introduction

Thank you very much for your confidence in AZUD FBC control units to solve your Filtration Equipments Automation needs. Please, read carefully this manual and you will find the answer to most of your questions.

However, **IF YOU HAVE ANY DOUBT OR NEED ADDITIONAL INFORMATION, PLEASE CONTACT US IN THE FOLLOWING NUMBER +34 968808402 OR IN THE E-MAIL azud@azud.com**

All the control units manufactured in SISTEMA AZUD, S.A are subject to strict quality control tests and are manufactured under a productive process which meets the requirements of the standard **ISO 9001/2000**.

Sistema AZUD is also committed with the environment, and is certified under the Environmental Management System of the standard **ISO 14001**.



This Manual contains some instructions and warnings which should be observed to obtain a correct installation, operation and subsequent maintenance of the Control Unit.

2. Characteristics of the Control Unit.

2.1 Introduction.

AZUD FBC Control Unit is able to control the automatic backflushing of the filtration equipments with different possibilities of start and actuation. AZUD FBC Control Unit integrates **the detection, control and activation systems** of the backflushing cycle of the filtration systems.

Electronic control system. Integrated controller to control all the detection and activation functions. It is assembled on an electric cabinet with degree of protection IP 54.

Detection system. Easy reading differential pressure gauge.

Activation system. 24 V NC three-way electrovalves

All these is completely assembled and contains the auxiliary elements which complete the electric and hydraulic system and which turns the Control Unit into an independent and automatic system.

2.2. Identification of the product.

In AZUD we identify each Control Unit with an **industrial label** with a unique serial number. The factory identifies the different control units with these labels.

The industrial label indicates: manufacturer, model, number of stations, serial number, device code, tension.

The label includes QR code to access the technical documentation of the product such as technical sheets, user manual, spare parts and/or maintenance and commissioning instructions.

The modification or elimination of the label cancels any warranty; and so impedes the identification of the Equipment.



2.3 Technical Data AZUD FBC Control Unit.

| | | |
|------------------|----------|----------|
| VOLTAGE | 220 V AC | 110 V AC |
| SOLENOIDS | 24 V AC | 24 V AC |
| ADMISSIBLE TEMP. | 5 – 60°C | 5 – 60°C |
| CONSUMTION | 19W | 19W |

| | | |
|--------|---------|-------------------------|
| | OUTPUTS | INPUTS |
| | 109 | 109 |
| NUMBER | 10 | 2 |
| TYPE | 24V AC | CONTACT FREE OF VOLTAGE |

*Stations or outputs number will depend on the Control Unit acquired up to 10 outputs maximum



Do not connect AZUD FBC Control Unit in installations fed by a power generator. The variations in voltage could damage it.



ANY CONNECTION/DISCONNECTION HANDING OF ELECTRONICAL AND/OR ELECTRICAL COMPONENTS ON THE CONTROL UNIT (PRESSURE DIFFERENTIAL SWITCH, EXTENSION MODULES) HAS TO BE DONE WITH POWER SUPPLY DISCONNECTED.

2.4 Types of activation and backflushing cycles.

1- By interval of working time of the installation.

A backflushing cycle will be activated each time the programming time passes.

2- By differential of pressure.

A backflushing cycle will be activated each time there is a differential of pressure in the equipment equal or higher than the regulated in the Differential Pressure Gauge, and after the confirmation time of the pressure gauge programmed in the **FBC**.

NOTE: If the differential of pressure in the equipment is higher than 3 bar, the control unit may not activate the backflushing cycle. It is required to open the filter and clean it manually.

3- Manually.

You can activate a backflushing cycle manually, through the keyboard of your Control Unit. The backflush will be activated when you keep pressed for some seconds the key OK.

AZUD FBC Control Unit will allow to keep all this options at the same time, or select just some of them.

2.5.- Working Description.

AZUD FBC Control Unit integrates all the control, detection and operation elements that allow AZUD HELIX AUTOMATIC filtration equipment to have complete autonomy. All the components are supplied already assembled, with the auxiliary elements that complete the electric and hydraulic system, which turn the Control Unit into an autonomous and automatic system.

The electronic control system and the electric auxiliary elements are placed in a water-tightness housing, completely isolated from the hydraulic components.

Working Description:

- The start of the sequential self-cleaning process is made when the Control Unit activates the backflushing cycle under one of the four possible orders: existing differential of pressure, attending to the frequency of irrigation, by direct actuation on the keyboard or by external signal.
- The programmer which integrates the Control Unit, activates the electric contact which supplies voltage to the NC solenoid, in charge of activating the first station that makes the self-cleaning process; transforming the electric signal in a hydraulic signal in charge of feeding the chamber of the 3-ways valve.
- Through the feeding of the chamber of the 3-ways valve it is made a movement of the internal piston which closes the entrance of water to the filter and communicates the interior of the filter with the drainage manifold. This allows the filtered water from the rest of filter from the outlet manifold, introduces to the filter in the opposite way from the filtration direction, activating the self-cleaning mechanism of DF-DISC filtration discs.
- The deactivation of the solenoid from station n.1 allows the 3-ways valve come back to the resting position and the filter to the filtration process.
- Once the station n.1 has finished the backflushing process, this is repeated sequentially until finishing all the stations in the filtration equipment.
- The end of the self-cleaning process coincides with the closure of the drainage outlet and the opening of the inlet to the filter from the inlet manifold, being re-established the initial filtration conditions.

3. Programming of AZUD FBC Control Unit.

3.1. Identify the controller firmware version

Identify the controller firmware version

To identify the controller firmware version of Filtron 1-10, navigate to SETTINGS screen. To enter in SETTING screen – Hold ENTER button for 3 seconds (Figure 1).

Skip the next screens: Main valve, Main valve delay, Dwell time, Dp Delay, Looping, Alarm, Delay valve, Delay valve delay, View Outputs, Pressure units (Bar, psi), and Calibration.

To skip the screens described above, press the ENTER key several times until you will see the firmware version screen (Figure 2).

To exit the SETTINGS screen, press the ENTER key until reaching the main screen or wait 1 minute.

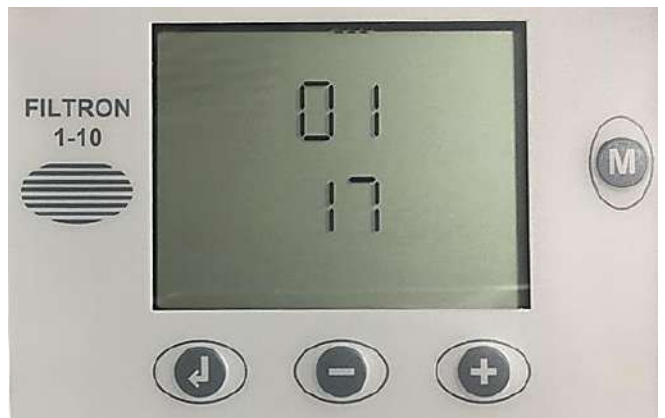

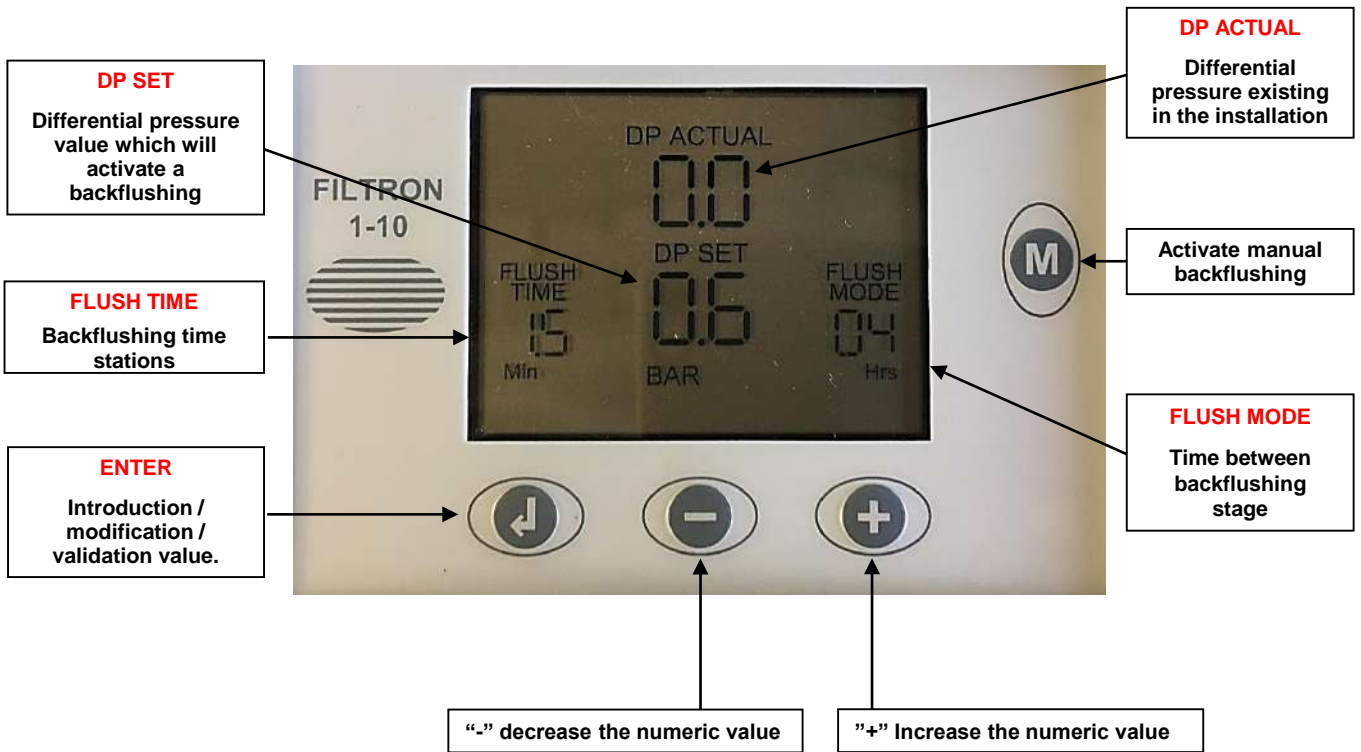

3.2. Control Unit Site Map



- 

ENTER: To modify the numeric value in the screen
To try selecty the display to modify and validation items.
- 

Push the button to M to activate manual backflushing.
The display are a hand.

- 

Push the buttons, both, in the same time.
In the Screen appear the time necessary to backflushing process again.

If you don't touch the screen around one minute, the control unit goit to standby.

3.3. Change in reaction to the Pressostat

When an element which temporarily cancels the backflushes is connected (see section 4.2), old versions of Filtron 1-10 stop the back-flushing cycle when the controller detects Low water pressure (Close contact in the pressostat input). When the Water pressure rises back, (Open contact in the Pressostat input), the controller does not continue the previous back flushing cycle that was stopped before.

Firmware version 1.16 of Filtron 1-10 includes different reaction to the Pressostat sensor. When the controller detects Low water pressure, the controller still stops the back-flushing process. But when the controller detects normal water pressure, it continues the previous back flushing cycle that was stopped before, from the point it got stopped.

3.4. Enable/Disable Sound

On SETTINGS screen, the last screen includes an option to edit the Sound mode.

To change the Sound mode, navigate to the Firmware version screen in SETTINGS (As described previously), press ENTER to skip to the next screen.

The Sound mode screen include the b letter:



To change the Sound mode, use the + and – keys

Yes means: The controller will make a sound when the user presses on any key. In addition, when the LCD is off (Controller on sleep mode), the controller makes sound every 20 seconds.

No means: The controller will make a sound when the user presses on any key. When the LCD is off (Controller on sleep mode), the controller does not make sound every 20 seconds.

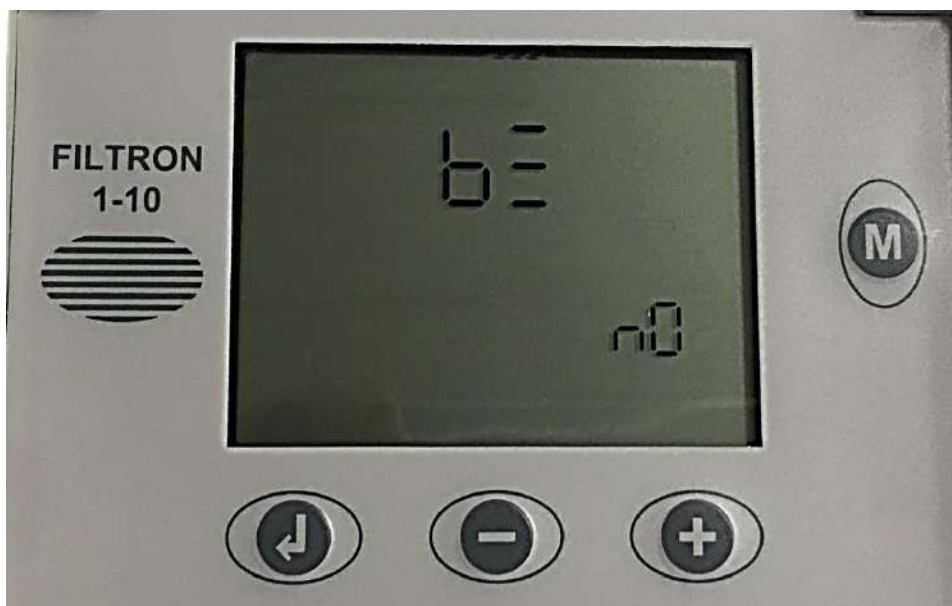

3.5. Control Unit Information



PRE DWELL
Anticipation time of the sustaining valve

Manual backflushing
Activated

Backflushing Canceled
(Contact closed Con & G)



Backflushing station activated.

3.6. Programming of Control Unit.

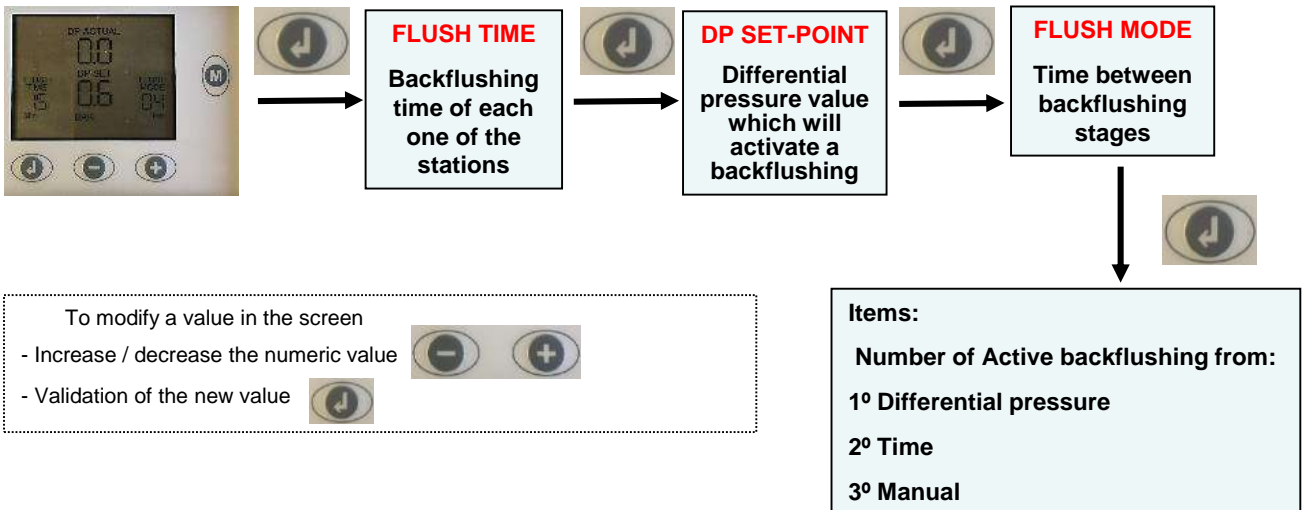

3.7. Control Unit configuration.

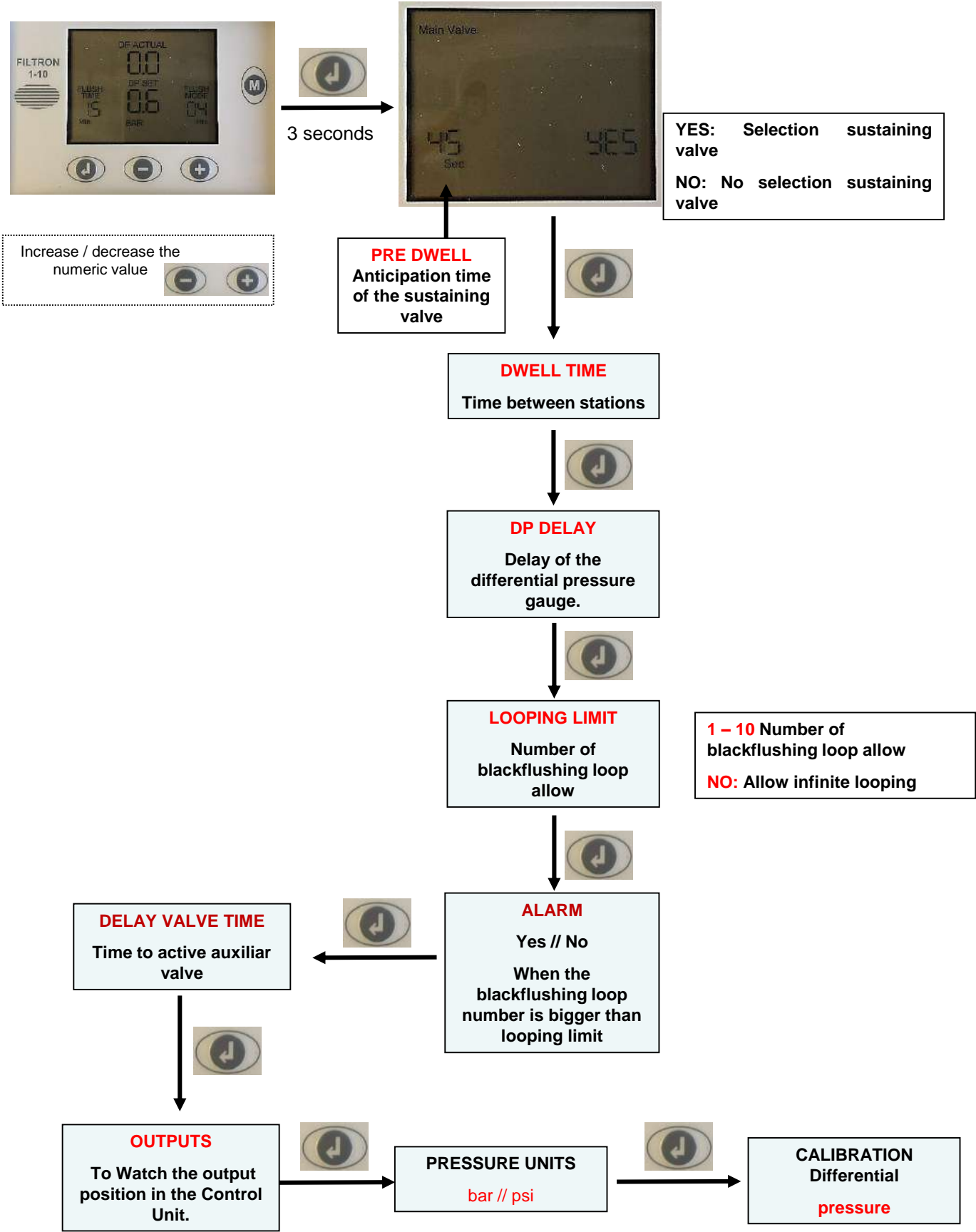

Following the different parameters to be programmed of your Control Unit will be introduced. **AZUD FBC** incorporates a standard programming which allow the user to start up the filtration equipment by the first time and being familiar with the programming to be adapted to the particular conditions of your installation.

3.8 Anticipation time of the sustaining valve.

Anticipation time of the signal of the sustaining electrovalve, which allows this to reach its regulation of pressure before starting the backflushing cycle.

If your equipment does not have this option, select sustaining valve NO.

3.9 Backflushing time of each one of the stations.

Time that remains active each one of the filtration stations which made the filtration system. The programmed time is the same for all the stations. During one cycle of activations it is made sequentially one activation for each station the system has programmed.

3.10 Time between stations.

Time that passes from the stop of the actuation of one filtration station and the start on the activation of the following.

During this time the system deactivates all the outlets active (general outlet).

3.11 Time between backflushing stages.

Minimal frequency to make the activation of a backflushing cycle, always the system in active filtration process.

3.12 Delay of the differential pressure gauge.

It is defined as a waiting time counted by the control unit during which the differential pressure must remain higher than the set value of pressure differential before it start the backflushing process. This is a feature especially designed to avoid unnecessary backflushing provoked by the equipment filling (Commissioning).

3.13 Number of Stations of the Filtration Equipment

The number of station is automatically selected by the control unit, using every available outputs.

3.14 Backflushing activating pressure differential

Indicates the pressure drop value set to activate the backflushing.

EXAMPLE

A **RECENTLY INSTALLED SYSTEM** which working with a **MAXIMUM FLOW**, has a **0,1 bar DIFFERENCE of pressure** . The recommended value is **0,3 - 0,4 bar**.

3.15 Consecutive backflushing cycles number

Indicates the number of consecutive backflushing cycles allowed by the Control Unit (from 1 to 10)

In case of consecutive backflushings due to pressure differential, check the set pressure drop value and increase it if it is convenient.

3.16 Activation alarms

Alarm allocation when the equipment surpass the allowed number of consecutive backflushings.

3.17 Automatic calibration

Automatic calibration of the electronic differential pressure gauge. For a proper calibration of the differential pressure gauge, the sensor's ports must remain at atmospheric pressure during the process

3.18 Pressure measurement units.

Bar/PSI.

4. Elementos auxiliares

4.1. How to activate backflashes by external pressure differential switch ?

If you want to backflush by external pressure differential switch: connect it to the inputs D and G as shown in the picture.



Electronic pressure differential switch



IMPORTANT: IF YOU CONNECT AN EXTERNAL PRESSURE DIFFERENTIAL SWITCH YOU WILL NOT BE ABLE TO BACKFLUSH BY ELECTRONIC PRESSURE DIFFERENTIAL SWITCH

4.2. How to connect an element which temporarily cancels the backflashes?

If you wish to temporarily cancel backflashes while any equipment or installation element are operating:

To **cancel the backflashes** connect inputs CON and G (by means of a jumper)

Connect to inputs CON and G an element that provides a potential free contact.



4.3. Anticipation signal. Sustaining valve.

This signal can be used for the connection of any element which needs to be activated **in advance and during the backflushing cycle**.

Sustaining valve will always be connected to the last output AVAILABLE.

AZUD HELIX AUTOMATIC equipment needs a minimum pressure around the backflushing process. If your installation doesn't guarantee the minimum pressure, we could provide the KIT sustaining valve.

4.4. HYDRAULIC SUSTAINING VALVE KIT FUNCTIONING

The sustaining valve activation allows to regulate the upstream pressure according to the pilot regulation.

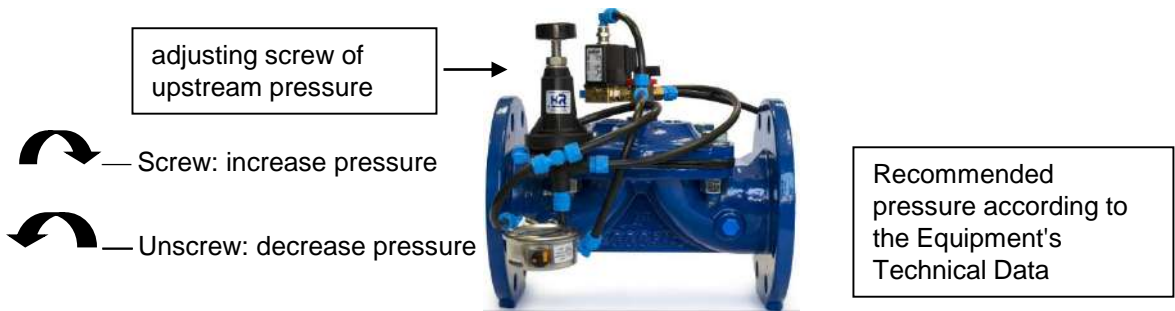

Sustaining valve kit is an OPTIONAL component for your equipment

AZUD RECOMMENDS TO HAVE ALWAYS ACTIVE THE BACKFLUSHING BY TIME OPTION

5. Components and spare parts.

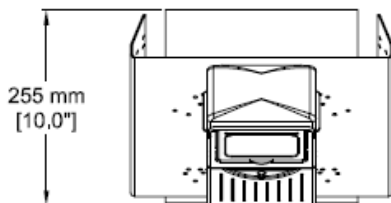
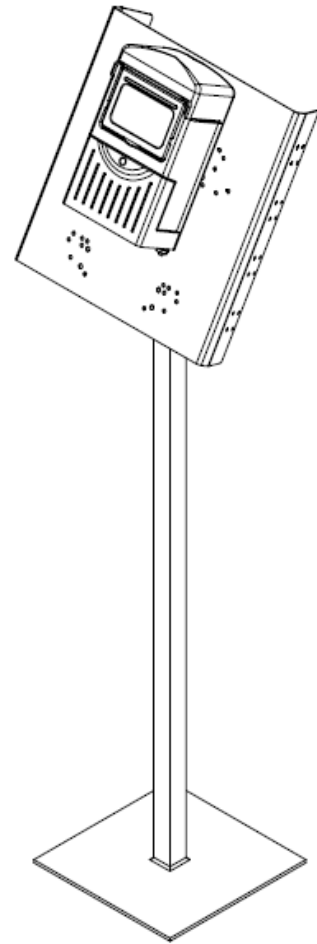
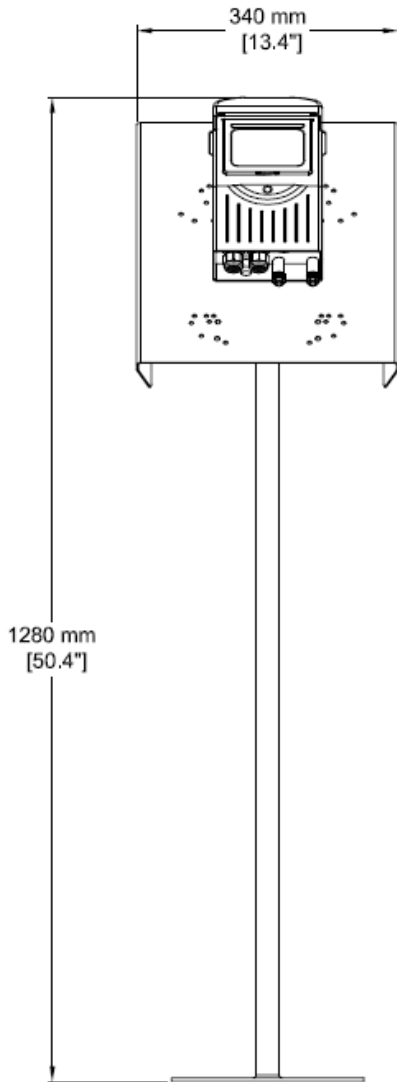

NOTE: THE SPARES ARE THE COMPONENTS WITH A CODE.
TO THE REQUEST OF OTHER COMPONENTS ASK YOUR DISTRIBUTOR.

Please indicate the serial number of the Control Unit to the request of spare parts.

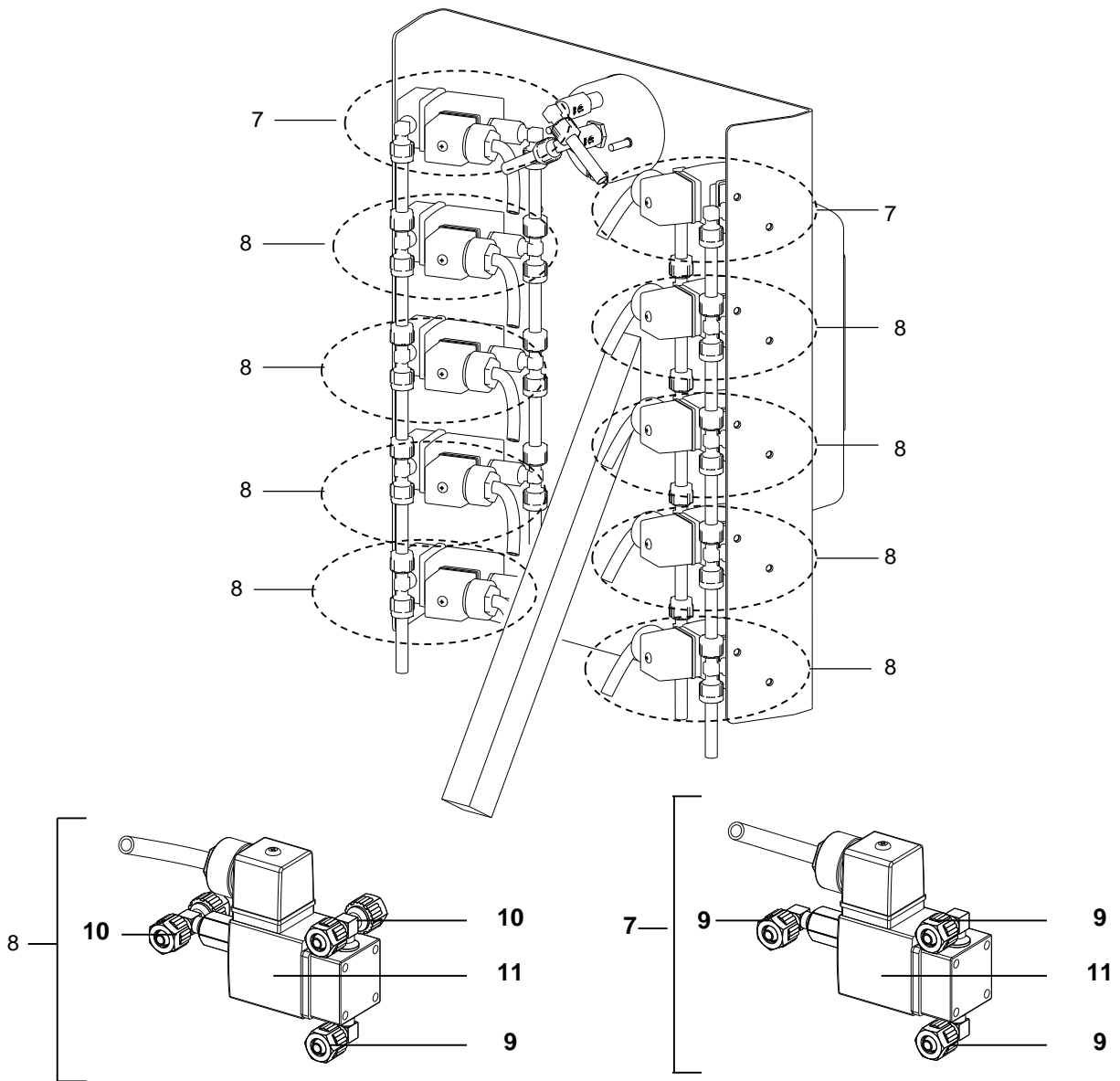

| COMPONENTS OF AZUD FBC CONTROL UNIT | | | |
|-------------------------------------|-------|----------------------------|----------|
| NUMBER | CODE | DESCRIPTION | MATERIAL |
| 1 | ----- | PROGRAMMER | ----- |
| 3 | ----- | CONTROL UNIT PANEL | ----- |
| 4 | ----- | CONTROL UNIT SUPPORT | ----- |
| 5 | ----- | CONTROL UNIT SUPPORT PIPE | ----- |
| 6 | ----- | M8X10 SCREW | ----- |
| 7 | ----- | 3 WAYS TYPE 1 ELECTROVALVE | ----- |
| 8 | ----- | 3 WAYS TYPE 2 ELECTROVALVE | ----- |
| 9 | ----- | 8x1/8" MALE ELBOW | ----- |
| 10 | ----- | 8x1/8" MALE THREADED TEE | ----- |
| 11 | ----- | 24V 3 WAYS NC ELECTROVALVE | ----- |

6. Safety Information

Preserve this manual so that the user of the Equipment could familiarize with it. Below there are some general instructions for a safe operation of the Equipment. These instructions are not a close list, the user must adopt as many security measures as necessary to guarantee his security. In this way, this safety information does not substitute the accident emergency measures which should be adopted.

Any additional requirement or change in its use could cause damages not covered by the warranty.



- The transmission of electric current to the human body could cause serious burns and even death.
- Take all the necessary precautions to avoid electric discharges and damages on people, goods and the equipment.
- The electrical installation should be carried out by a qualified electrician.
- Do use insulating clothing, authorized safety equipments and tools which insulate the electrical current.
- Do never take away the electrical protection.
- Do not touch the Control Unit with wet hands
- Do not put your hands in the electric boards, circuits ... There is a risk of electrocution.
- An independent earth connection for the equipment should be provided.
- The equipment´s installation should be carried out only by qualified staff.



- A 6A magneto-thermal switch and a 16 A differential should be installed as a cut-out switch, close and accessible to the user in accordance to current legislation and by qualified personnel.
- The equipment should have its own supply.
- The equipment´s feeding should be directly taken from the main switch, avoiding the connection of any other electric device in/to the same feed-line of the equipment. It is recommended the 1.5 mm² H05VV-F3G cable for its connection to the mains.
- As far as possible, set the power circuits away from the electrical machines.
- If the inductive circuits, as well as the contactor ones, electrovalves, etc, are installed next to the system, it is essential not to parasite your bobbin with RC filters.
- The fluctuations of the net are acceptable just up to the indicated tolerances ($\pm 5\%$).
- Do not connect control circuits (relays, contactors) to the connection terminals of the system to the net.
- Avoid electromagnetic interferences. This kind of interferences are due mainly to: electric engines, transformation centres, cables of electric energy transmission, power contactors and any other electrical power mechanism without the proper electromagnetic insulation.

7. Installation Instructions.

7.1 installation of the Support

To assemble the Control Unit support, place the **plate tube** on the **support**, and adjust it with fixation screws. To Fix the support to the ground, use adequate sleeper screws depending on the type of ground for the fixing of the support on the ground.

7.2 Hydraulic connection of the Control Unit with the Filtration Equipment.

The linkage is carried out due to the junction of each of the command microtubes of the Control Unit with its Filtration Equipment homologous

The nomenclature used is the following:

| COMMAND | DESCRIPTION: use and connection |
|-----------|---|
| T | PRESSURE TAP: For the feeding of all the command circuit. It must match with the maximum pressure point of all the installation, which usually is the inlet manifold. |
| D | DRAINAGE: Command for the water drainage of the electrovalves chambers. It drains the water housed in the valve chamber in the moment in which the corresponding filter or station activation stops. <u>It should ALWAYS have an exit to the atmosphere</u> |
| P1 | Pressure tap in inlet manifold , to be connected to the differential pressure gauge*. There is an intake in the inlet manifold with a ¼" filter + a 1/8" male elbow to connect the command. |
| P2 | Pressure tap in outlet manifold , to be connected to the pressure differential gauge*. There is an intake in the outlet manifold with a ¼" filter + a 1/8" male elbow to connect the command. |
| E1 | Station 1: Command in charge of the feeding of the hydraulic relay and/ or the three-way valve chamber for the activation of the station or n°1 filter backflushing process, and its drainage from the moment in which the n°1 electrovalve activation stops. |
| E2 | Station 2: Command in charge of the feeding of the hydraulic relay and/ or the three-way valve chamber for the activation of the station or n°2 filter backflushing process, and its drainage from the moment in which the n°2 electrovalve activation stops |
| E3 ... In | ... |

* GLOSSARY

| | |
|------------------------------------|--|
| STATION | We understand by station each of the groups of filters which backflush altogether in the same signal of the Control Unit. A station can be formed by one or several filters. |
| DIFFERENTIAL PRESSURE GAUGE | It indicates in the display, the differential pressure value between intake P1 and P2 as well as the stipulated value through which it is established the contact for the activation of a backflush. |

RESET



AZUD FBC 109T 220-110 V AC CONTROLLER GRAPHIC CHART

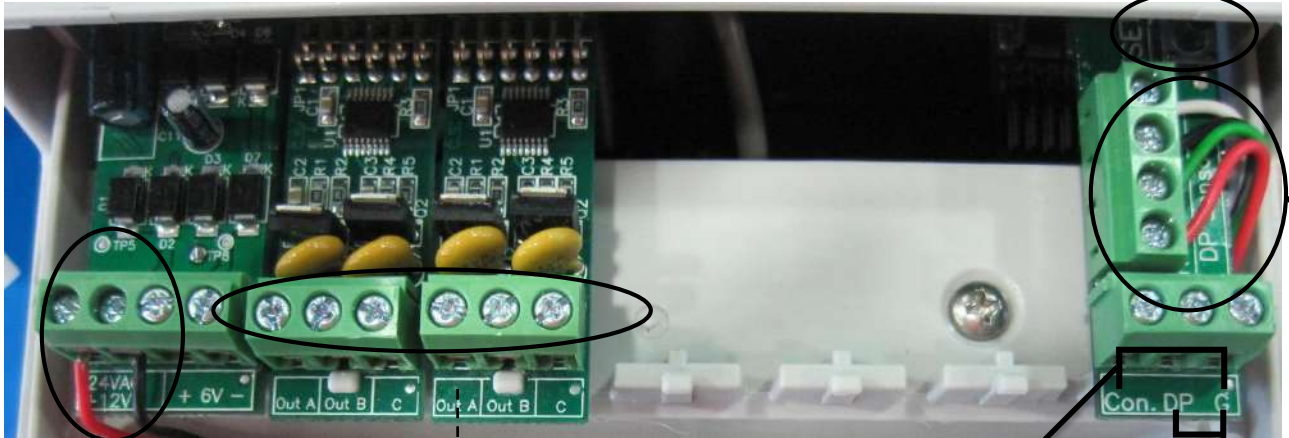

220-110 V AC AZUD FBC 109T

Closed contact (Con. and G connection): Backflusing canceled.
Open contact (no connection): Equipment functioning according to programming.

External pressure differential switch connections DP and G

OUTPUTS

ALARM IN PENULTIMATE OUTPUT
 (when available)

Integrated pressure differential switch

SUSTAINING VALVE IN LAST OUTPUT

CONTROL UNIT DOES NOT ALLOW THE SIMULTANEOUS CONNECTION OF INTEGRATED PRESSURE DIFFERENTIAL SWITCH AND EXTERNAL PRESSURE DIFFERENTIAL SWITCH.

ANY CONNECTION/DISCONNECTION HANDLING OF ELECTRONICAL AND/OR ELECTRICAL COMPONENTS ON THE CONTROL UNIT (PRESSURE DIFFERENTIAL SWITCH, EXTENSION MODULES) HAS TO BE DONE WITH POWER SUPPLY DISCONNECTED.

ELECTRIC CONNECTION INSTALLED ON THE CONTROL UNIT FBC 109T IN THE FACTORY FOR A 220 V AC EQUIPMENT

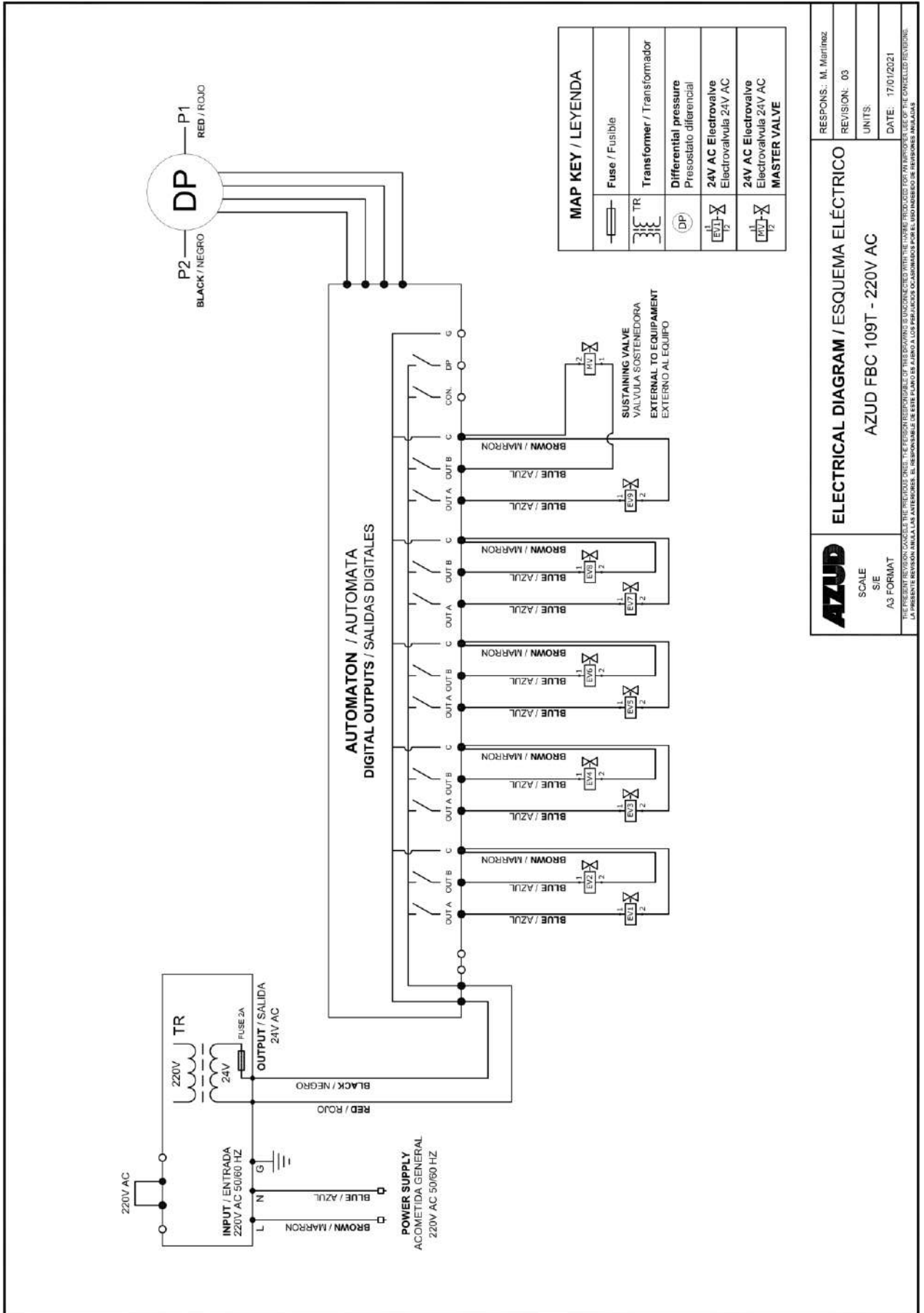

| MAP KEY / LEYENDA | |
|-------------------|---|
| | Fuse / Fusible |
| | Transformer / Transformador |
| | Differential pressure Presostato diferencial |
| | 24V AC Electrovalve Electrovalvula 24V AC |
| | 24V AC Electrovalve Electrovalvula 24V AC |
| | MASTER VALVE |

| | | |
|-------------------------------|---|--|
| SCALE S/E AS FORMAT | ELECTRICAL DIAGRAM / ESQUEMA ELÉCTRICO AZUD FBC 109T - 220V AC | RESPONDS.: M. Martínez REVISION: 03 UNITS: DATE: 17/01/2021 |
|-------------------------------|---|--|

ELECTRIC CONNECTION INSTALLED ON THE CONTROL UNIT FBC 109T IN THE FACTORY FOR A 110 V AC EQUIPMENT

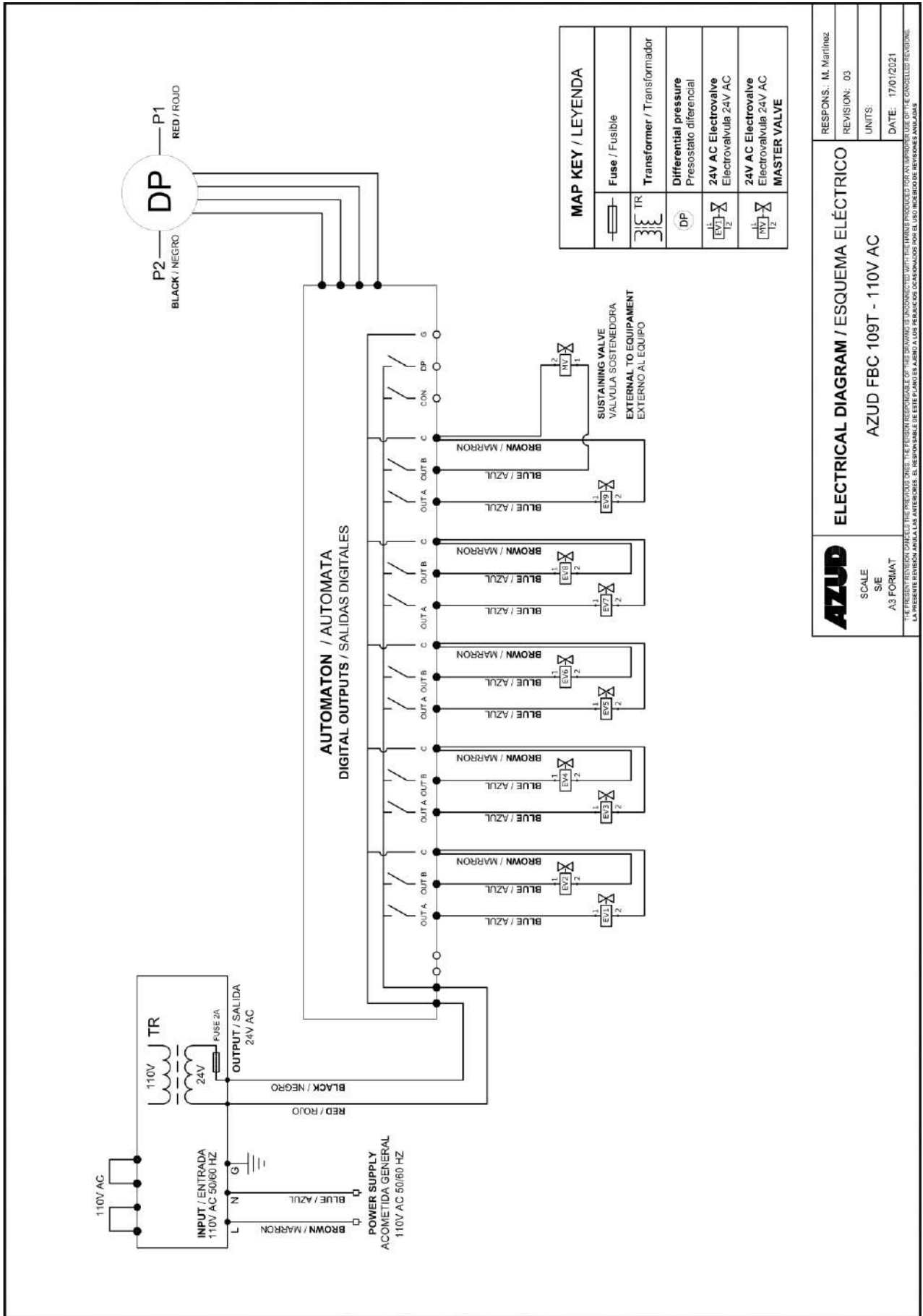

| 109T/1 – 109T/10 | | | | |
|----------------------|--------|--|-------------------|-------------------------|
| COMMON INPUTS (G) | INPUTS | | FUNCTION | TYPE |
| | DP | ACTIVATION OF BACKFLUSHING BY DIFFERENTIAL PRESSURE OR EXTERNAL SIGNAL | BACKFLUSHING | CONTACT FREE OF VOLTAGE |
| | CON | DISABLE THE CONTROL UNIT TO PROVOKE BACKFLUSHES | STOP BACKFLUSHING | CONTACT FREE OF VOLTAGE |

Depending on the station number installed on the control unit, 1 or 2 outputs will be available. For an even number of stations, 2 outputs will be available, for an uneven number of stations, 1 output will be available. Available outputs need to be assigned in order to prevent them being interpreted as stations.

Penultimante available output (When available) → Alarm

Last available output, always destined to sustaining valve.

| 109T/1 | | | | |
|---------|-------|---------------------------------|------------------|-----------------|
| OUTPUTS | | | FUNCTION | TYPE |
| C | OUT A | ACTIVATION STATION N°1 SOLENOID | BACKFLUSHING | 24 V AC TENSION |
| | OUT B | ACTIVATION SUSTAINING VALVE | PRESSURE SUSTAIN | |

| 109T/2 | | | | |
|---------|-------|---------------------------------|------------------|-----------------|
| OUTPUTS | | | FUNCTION | TYPE |
| C | OUT A | ACTIVATION STATION N°1 SOLENOID | BACKFLUSHING | 24 V AC TENSION |
| | OUT B | ACTIVATION STATION N°2 SOLENOID | BACKFLUSHING | 24 V AC TENSION |
| C | OUT A | ALARM ACTIVATION | ALARM | 24 V AC TENSION |
| | OUT B | ACTIVATION SUSTAINING VALVE | PRESSURE SUSTAIN | 24 V AC TENSION |

| 109T/3 | | | | |
|---------|-------|---------------------------------|------------------|-----------------|
| OUTPUTS | | | FUNCTION | TYPE |
| C | OUT A | ACTIVATION STATION N°1 SOLENOID | BACKFLUSHING | 24 V AC TENSION |
| | OUT B | ACTIVATION STATION N°2 SOLENOID | BACKFLUSHING | 24 V AC TENSION |
| C | OUT A | ACTIVATION STATION N°3 SOLENOID | BACKFLUSHING | 24 V AC TENSION |
| | OUT B | ACTIVATION SUSTAINING VALVE | PRESSURE SUSTAIN | 24 V AC TENSION |

| 109T/4 | | | | |
|----------|--------------|---------------------------------|------------------|-----------------|
| OUTPUT | | | FUNCTION | TYPE |
| C | OUT A | ACTIVATION STATION N°1 SOLENOID | BACKFLUSHING | 24 V AC TENSION |
| | OUT B | ACTIVATION STATION N°2 SOLENOID | BACKFLUSHING | 24 V AC TENSION |
| C | OUT A | ACTIVATION STATION N°3 SOLENOID | BACKFLUSHING | 24 V AC TENSION |
| | OUT B | ACTIVATION STATION N°4 SOLENOID | BACKFLUSHING | 24 V AC TENSION |
| C | OUT A | ALARM ACTIVATION | ALARM | 24 V AC TENSION |
| | OUT B | SUSTAINING VALVE ACTIVATION | PRESSURE SUSTAIN | 24 V AC TENSION |

| 109T/5 | | | | |
|----------|--------------|---------------------------------|------------------|-----------------|
| OUTPUT | | | FUNCTION | TYPE |
| C | OUT A | ACTIVATION STATION N°1 SOLENOID | BACKFLUSHING | 24 V AC TENSION |
| | OUT B | ACTIVATION STATION N°2 SOLENOID | BACKFLUSHING | 24 V AC TENSION |
| C | OUT A | ACTIVATION STATION N°3 SOLENOID | BACKFLUSHING | 24 V AC TENSION |
| | OUT B | ACTIVATION STATION N°4 SOLENOID | BACKFLUSHING | 24 V AC TENSION |
| C | OUT A | ACTIVATION STATION N°5 SOLENOID | BACKFLUSHING | 24 V AC TENSION |
| | OUT B | SUSTAINING VALVE ACTIVATION | PRESSURE SUSTAIN | 24 V AC TENSION |

| 109T/6 | | | | |
|----------|--------------|---------------------------------|------------------|-----------------|
| OUTPUT | | | FUNCTION | TYPE |
| C | OUT A | ACTIVATION STATION N°1 SOLENOID | BACKFLUSHING | 24 V AC TENSION |
| | OUT B | ACTIVATION STATION N°2 SOLENOID | BACKFLUSHING | 24 V AC TENSION |
| C | OUT A | ACTIVATION STATION N°3 SOLENOID | BACKFLUSHING | 24 V AC TENSION |
| | OUT B | ACTIVATION STATION N°4 SOLENOID | BACKFLUSHING | 24 V AC TENSION |
| C | OUT A | ACTIVATION STATION N°5 SOLENOID | BACKFLUSHING | 24 V AC TENSION |
| | OUT A | ACTIVATION STATION N°6 SOLENOID | BACKFLUSHING | 24 V AC TENSION |
| C | OUT A | ALARM ACTIVATION | ALARM | 24 V AC TENSION |
| | OUT B | SUSTAINING VALVE ACTIVATION | PRESSURE SUSTAIN | 24 V AC TENSION |

| 109T/7 | | | | |
|----------|--------------|---------------------------------|------------------|-----------------|
| OUTPUT | | | FUNCTION | TYPE |
| C | OUT A | ACTIVATION STATION N°1 SOLENOID | BACKFLUSHING | 24 V AC TENSION |
| | OUT B | ACTIVATION STATION N°2 SOLENOID | BACKFLUSHING | 24 V AC TENSION |
| C | OUT A | ACTIVATION STATION N°3 SOLENOID | BACKFLUSHING | 24 V AC TENSION |
| | OUT B | ACTIVATION STATION N°4 SOLENOID | BACKFLUSHING | 24 V AC TENSION |
| C | OUT A | ACTIVATION STATION N°5 SOLENOID | BACKFLUSHING | 24 V AC TENSION |
| | OUT B | ACTIVATION STATION N°6 SOLENOID | BACKFLUSHING | 24 V AC TENSION |
| C | OUT A | ACTIVATION STATION N°7 SOLENOID | BACKFLUSHING | 24 V AC TENSION |
| | OUT B | SUSTAINING VALVE ACTIVATION | PRESSURE SUSTAIN | 24 V AC TENSION |

| 109T/8 | | | | |
|----------|--------------|---------------------------------|------------------|-----------------|
| OUTPUT | | | FUNCTION | TYPE |
| C | OUT A | ACTIVATION STATION N°1 SOLENOID | BACKFLUSHING | 24 V AC TENSION |
| | OUT B | ACTIVATION STATION N°2 SOLENOID | BACKFLUSHING | 24 V AC TENSION |
| C | OUT A | ACTIVATION STATION N°3 SOLENOID | BACKFLUSHING | 24 V AC TENSION |
| | OUT B | ACTIVATION STATION N°4 SOLENOID | BACKFLUSHING | 24 V AC TENSION |
| C | OUT A | ACTIVATION STATION N°5 SOLENOID | BACKFLUSHING | 24 V AC TENSION |
| | OUT B | ACTIVATION STATION N°6 SOLENOID | BACKFLUSHING | 24 V AC TENSION |
| C | OUT A | ACTIVATION STATION N°7 SOLENOID | BACKFLUSHING | 24 V AC TENSION |
| | OUT B | ACTIVATION STATION N°8 SOLENOID | BACKFLUSHING | 24 V AC TENSION |
| C | OUT A | ALARM ACTIVATION | ALARM | 24 V AC TENSION |
| | OUT B | SUSTAINING VALVE ACTIVATION | PRESSURE SUSTAIN | 24 V AC TENSION |

| 109T/9 | | | | |
|----------|--------------|---------------------------------|------------------|-----------------|
| | OUTPUT | | FUNCTION | TYPE |
| C | OUT A | ACTIVATION STATION N°1 SOLENOID | BACKFLUSHING | 24 V AC TENSION |
| | OUT B | ACTIVATION STATION N°2 SOLENOID | BACKFLUSHING | 24 V AC TENSION |
| C | OUT A | ACTIVATION STATION N°3 SOLENOID | BACKFLUSHING | 24 V AC TENSION |
| | OUT B | ACTIVATION STATION N°4 SOLENOID | BACKFLUSHING | 24 V AC TENSION |
| C | OUT A | ACTIVATION STATION N°5 SOLENOID | BACKFLUSHING | 24 V AC TENSION |
| | OUT B | ACTIVATION STATION N°6 SOLENOID | BACKFLUSHING | 24 V AC TENSION |
| C | OUT A | ACTIVATION STATION N°7 SOLENOID | BACKFLUSHING | 24 V AC TENSION |
| | OUT B | ACTIVATION STATION N°8 SOLENOID | BACKFLUSHING | 24 V AC TENSION |
| C | OUT A | ACTIVATION STATION N°9 SOLENOID | BACKFLUSHING | 24 V AC TENSION |
| | OUT B | SUSTAINING VALVE ACTIVATION | PRESSURE SUSTAIN | 24 V AC TENSION |

| 109T/10 | | | | |
|----------|--------------|----------------------------------|--------------|-----------------|
| | OUTPUT | | FUNCTION | TYPE |
| C | OUT A | ACTIVATION STATION N°1 SOLENOID | BACKFLUSHING | 24 V AC TENSION |
| | OUT B | ACTIVATION STATION N°2 SOLENOID | BACKFLUSHING | 24 V AC TENSION |
| C | OUT A | ACTIVATION STATION N°3 SOLENOID | BACKFLUSHING | 24 V AC TENSION |
| | OUT B | ACTIVATION STATION N°4 SOLENOID | BACKFLUSHING | 24 V AC TENSION |
| C | OUT A | ACTIVATION STATION N°5 SOLENOID | BACKFLUSHING | 24 V AC TENSION |
| | OUT B | ACTIVATION STATION N°6 SOLENOID | BACKFLUSHING | 24 V AC TENSION |
| C | OUT A | ACTIVATION STATION N°7 SOLENOID | BACKFLUSHING | 24 V AC TENSION |
| | OUT B | ACTIVATION STATION N°8 SOLENOID | BACKFLUSHING | 24 V AC TENSION |
| C | OUT A | ACTIVATION STATION N°9 SOLENOID | BACKFLUSHING | 24 V AC TENSION |
| | OUT B | ACTIVATION STATION N°10 SOLENOID | BACKFLUSHING | 24 V AC TENSION |



8. Maintenance Instructions.



Maintenance operations should be made by qualified staff

In this section are described some very useful actions for the preparation of the Equipment 's Maintenance Plan. The checking period depends on the operation conditions, characteristics of the water to be filtered, operation hours, ...

AZUD recommends a three months period between the different reviews of the components which involve the disassembly of each element. However, **this period should be determined by the user** according to the unique characteristics of its installation.

| DAILY ACTIONS |
|--|
| General visual inspection of the Unit Control |
| PERIODICALLY ACTIONS |
| 1. Checking of the hydraulic circuit of the Control Unit |
| 2. Backflush manual activation to check the correct operation of all the solenoids. |
| 3. Auxiliary Filter Checking (See Filtration Equipment Manual) |
| 4. 1/4" In- line filter checking (the ones of the Equipment and the Sustaining)(See Filtration Equipment Manual) |
| 5. Checking of the electrovalves conditions |
| 6. Checking of backflush activation by pressure differential. |
| YEARLY ACTIONS OR WHEN NEEDED |
| Checking of the programming for its adaptation according to changes in the process conditions. |

9. Possible problems-causes-solutions

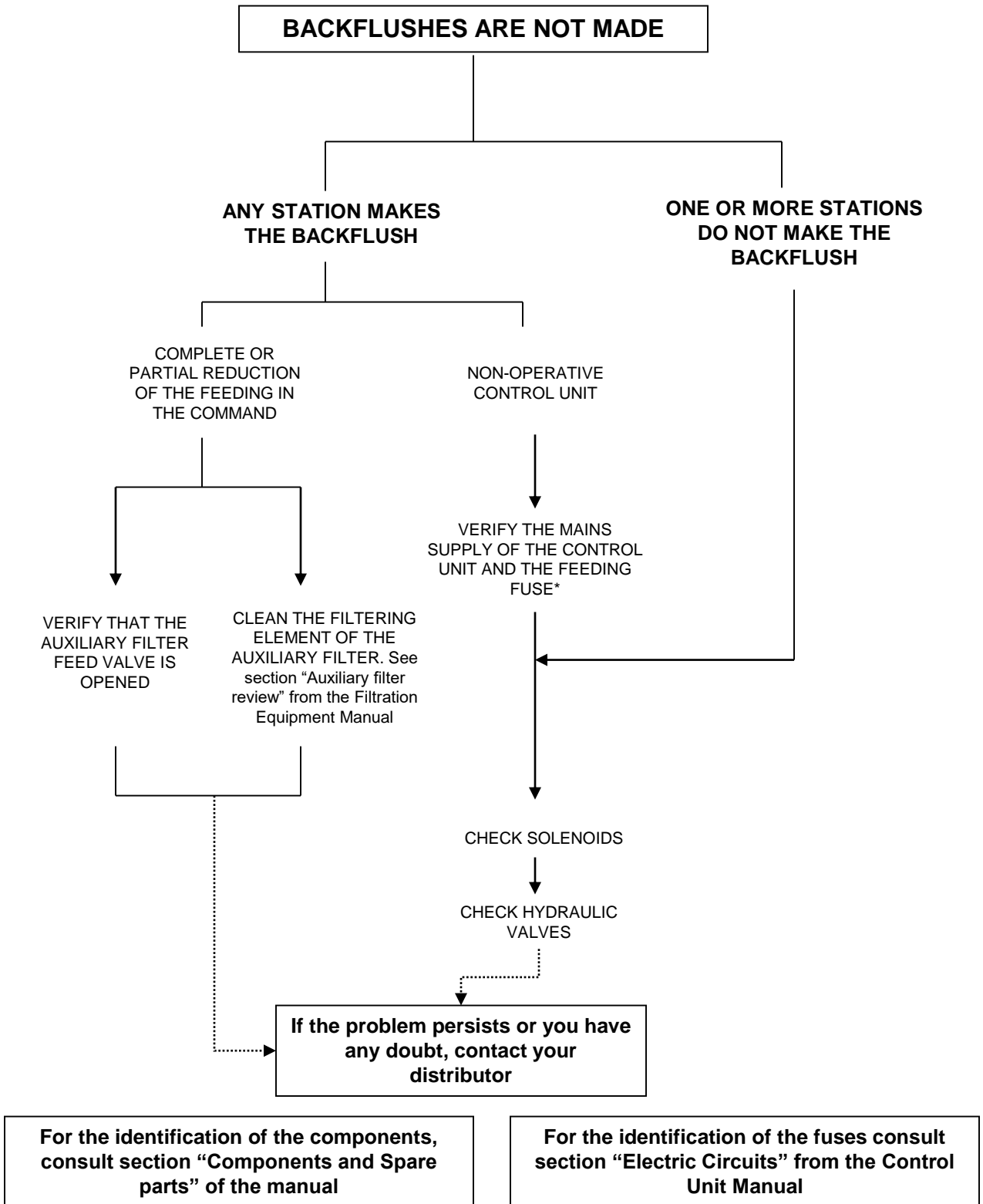

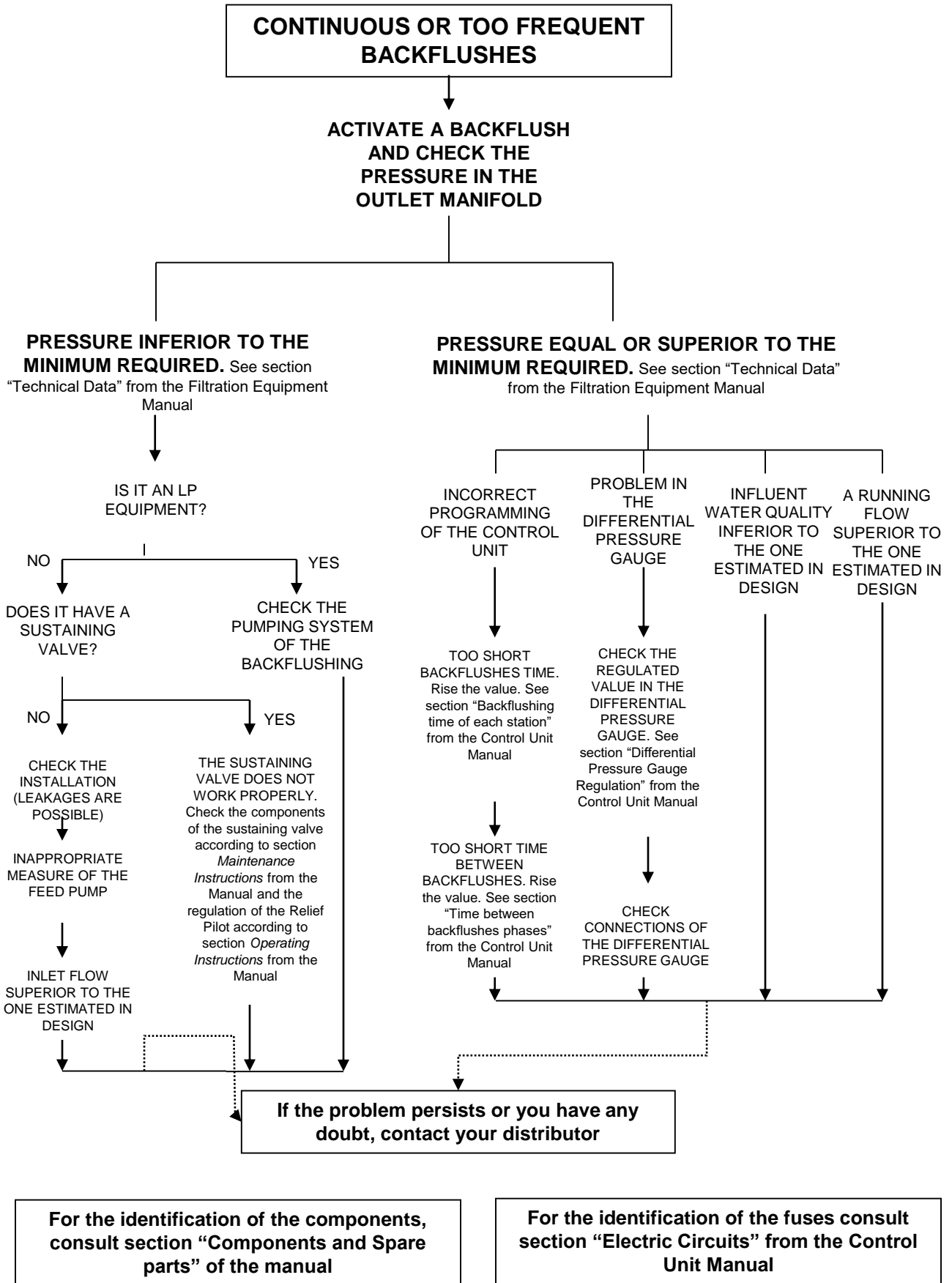

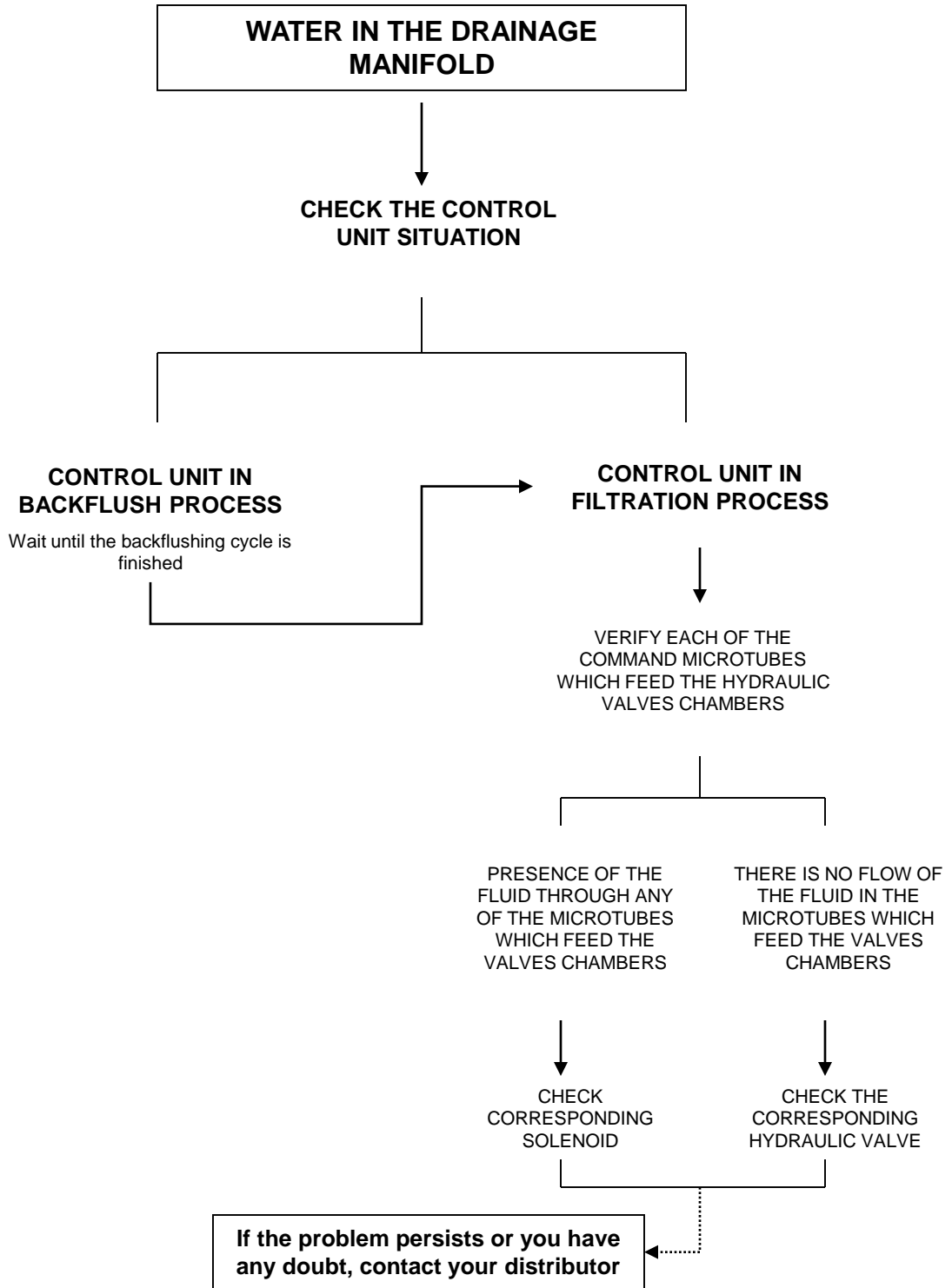

For the identification of the components, consult section “Components and Spare parts” of the manual

For the identification of the fuses consult section “Electric Circuits” from the Control Unit Manual

10. Warranty

1. Sistema Azud, S.A. agrees formally either to replace any defective component or to repair any defect that is exclusive responsibility of Sistema Azud, S.A., provided that the buyer informs Sistema Azud, S.A. about the defects in a maximum period of one year from the delivery date. Once that the period has expired, either refunds or claims due to this reason will not be accepted. The warranty will cover no cost of displacement, neither the shipment of pieces and/or materials, nor the expenses of assembly or disassembling of the products.
2. The express warranty provided herein is effective only if claim is made by written notice within the applicable warranty period and postmarked within thirty days after the discovery of the defect on which the claim is based.
3. This warranty will not cover any defects that result either from a wrong installation of the products and materials, an incorrect use of them or the non-observance of the User's Manual content. And in general, this warranty will not cover any other kind of irregularity beyond the operation of the product.
4. This warranty will not cover the damage caused by operating the products in places, installations, natural environments or aims, without suitable conditions and characteristics to obtain an optimal output.
5. Repairs made during the warranty period will not prolong the duration of the warranty.
6. This warranty will cover only the products and materials or components which have been manufactured by Sistema Azud, S.A. and have been directly bought from Sistema Azud, S.A. This warranty is not a consumer or end user warranty and does not extend to anyone other than those trade costumers who purchase directly in Sistema Azud, S.A.
7. In particular, it is excluded from this warranty damages and failures in the sold materials that result from fortuitous facts or force majeure; and specifically and without limit, those caused by insects or rodents; higher pressure than recommended; those caused by inadequate electrical tensions; by operations made in different conditions to the specifically rank of the product management; by qualities of water, by acid environments, decantations, precipitations, bacteria or algae agglutinations. It will be excluded either the breaking caused by the lack of a pre-filter in the installation, or not protected installations against water hammer, or other hydraulic or electrical incidents.
8. This warranty will not cover materials which have been either repaired or modified by an unauthorised person, or have been used, installed or modified without following the instructions given by Sistema Azud, S.A.
9. Sistema Azud, S.A. will be allowed to check the defects reported by the purchaser using the means that may be considered appropriate. The purchaser is not allowed to obstruct the proceedings of the people authorised by Sistema Azud, S.A. to verify the facts.
10. Sistema Azud, S.A. is not liable for direct, indirect, incidental, or consequential damages during periods of malfunction. Neither Sistema Azud, S.A. is liable for any loss or damage in the property, resulting from installer's negligence.
11. No person or organisation is authorised to introduce any modification in the present warranty. Except for the obligations specifically set forth in this warranty statement, in no event shall Sistema Azud, S.A. be liable for other incidental o damages.

Note down the Equipment's serial number to request any spare part or to consult about your Equipment

SERIAL NUMBER _____

MODEL _____

YEAR OF MANUFACTURE _____

Request your spare parts to:

SISTEMA AZUD, S.A.

Polígono Industrial Oeste • Avda. de las
Américas P. 6/6
30820 ALCANTARILLA – MURCIA- SPAIN
Tel. + 34 968 80 84 02
Fax: +34 968 80 83 02
E-mail: azud@azud.com
[http:// www.azud.com](http://www.azud.com)