

AZUD HELIX AUTOMATIC FT200 AA DLP

SELF-CLEANING DISC FILTRATION EQUIPMENT

Working conditions

Salinity	< 6000 mg/l
Max. working pressure	10 bar (145 psi)
Min. working pressure	0.8 bar (11.6 psi)
Min. air pressure*	4.5 bar (65 psi)
Max. air pressure*	6 bar (87 psi)
Air flow per duration	18 l/s (285 gpm) x 10 s
Backwash volume	10 l water per filter (2.6 gal)
pH	4 - 11
Water temperature	≤ 60 °C (140 °F)

*Compressed air pressure > Water pressure

Filtration degrees (micron)

400 200 130 100 50 20 10 5

DLP Technology

Low Pressure Backflush



DESCRIPTION

Self-cleaning disc filtration equipment composed by 1 to 10 filters AZUD HELIX AUTOMATIC Ø2" with discs AZUD MG/WS, which perform an in-depth 3D filtration, installed in-line on Ø2"-Ø8" inlet/outlet manifolds. Includes Ø2" backwash valves 3-way membrane type and the innovative DLP TECHNOLOGY, that enable the sequential low-pressure backwashing of each filter using a mix of filtered water and compressed air stored in an auxiliary tank, while continues the filtered water supply downstream. The patented AZUD HELIX anti-clogging deflector provides a reliable filtration thanks to an effect of centrifugal separation, with less backwash frequency and less water and energy consumption.

Smart, compact and modular plug&play solution, made of technical thermoplastics, increases the shelf life of the installation providing a long-term operation with minimum operational costs and less maintenance downtime.

APPLICATIONS



> Make-up water filtration



> Filtration in tanks, lakes and fountains



> Disinfection system protection



> Particles recovery



> Water reuse

Avda. de las Américas P. 6/6 • Polígono Industrial Oeste
30820 Alcantarilla • Murcia - Spain • Apdo. 147 • 30169 San Ginés • Murcia - Spain
Tel.: +34 968 808 402 • Fax.: +34 968 808 302 • E-mail: info@azud.com • www.azud.com



HOW DO THEY WORK

FILTRATION PHASE:

- Water flows from the inlet manifold to the inside of the filter, passing through the anti-clogging deflector AZUD HELIX, which throws the heavy particles away from the disc stack, avoiding the quick clogging of the filter and minimizing the backwash frequency.
- Water flows OUT-IN through the disc stack to the outlet manifold while particles bigger than the filtration degree are trapped in the disc.

SELF-CLEANING PHASE:

- During the automatic backwash, a water-air mix is made, providing a more energetic and effective cleaning with a 80% water saving.
- The water-air mix flows IN-OUT, decompressing the disc stack. High-speed flushing water flowing through the spray nozzles, creates a tangential cleaning effect that flush out the trapped particles.

▶ Check our YouTube channel for more details

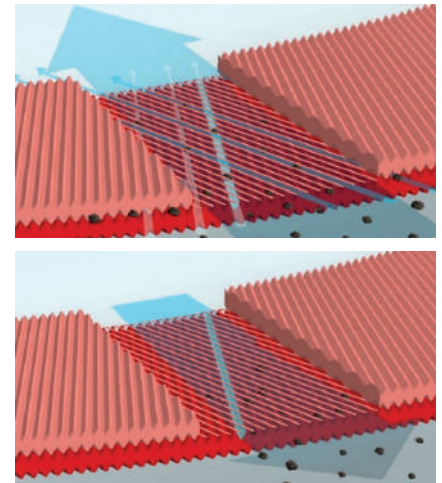

MODELS

Filtration area	Model	Q max. 50 µm* m³/h (gpm)	Q max. 130 µm* m³/h (gpm)	Connection	INLET AND OUTLET MANIFOLD			AZUD FBC control unit**
					DIN 2576	ANSI B16.5 CLASS 150	Grooved	
1620 cm²	FT201 AA 1 filter Ø2"	14 (62)	21 (92)	Ø2"			•	101/1 AA
3240 cm²	FT202 AA 2 filter Ø2"	28 (123)	42 (185)	Ø3"	•	•	•	110/2 AA
4860 cm²	FT203 AA 3 filter Ø2"	42 (185)	50 (220) 63 (277)	Ø3" Ø4"	•	•	•	110/3 AA
6480 cm²	FT204 AA 4 filter Ø2"	56 (246)	80 (352) 84 (370)	Ø4" Ø6"	•	•	•	110/4 AA
8100 cm²	FT205 AA 5 filter Ø2"	70 (308)	80 (352) 105 (462)	Ø4" Ø6"	•	•	•	110/5 AA
9720 cm²	FT206 AA 6 filter Ø2"	84 (370)	126 (555)	Ø6"	•	•	•	110/6 AA
11340 cm²	FT207 AA 7 filter Ø2"	98 (431)	147 (647)	Ø6"	•	•	•	110/7 AA
12960 cm²	FT208 AA 8 filter Ø2"	112 (493)	160 (705) 168 (740)	Ø6" Ø8"	•	•	•	110/8 AA
14580 cm²	FT209 AA 9 filter Ø2"	126 (555)	160 (705) 189 (832)	Ø6" Ø8"	•	•	•	110/9 AA
16200 cm²	FT210 AA 10 filter Ø2"	140 (616)	160 (705) 210 (925)	Ø6" Ø8"	•	•	•	110/10 AA

DRAINAGE MANIFOLD: Ø3" Grooved/PVC

*Maximum flowrate is limited by the size and type of the auxiliary elements (manifold, flanges and valves).

**AZUD FBC control unit not included with the equipment.

MATERIALS OF CONSTRUCTION

Filters	Backwash valves Inlet/outlet/drainage manifolds	Scheme
Filters Ø2" (1-10 units) <ul style="list-style-type: none"> • MG/WS disc: PP/HDPE • Support structure: rPP • Base-lid: rPA • Spring: SS 302 • Clamp: SS 304 • Sealing o-rings: NBR/HDPE 	Valves Ø2" 3 way-membrane (2 units / filter) <ul style="list-style-type: none"> • Body: rPA • Axis, seat and spring: SS • Sealing o-rings: NBR • Command: Pneumatic (PN) Manifolds: HDPE PE-100 Flanges: Aluminum AA tank: SS 304 epoxy coated	

PP: Polypropylene rPP: Reinforced polypropylene SS: Stainless steel rPA: Reinforced polyamide HDPE: High density polyethylene NBR: Nitrile rubber

MICRON 100 130 200 400

FT201 AA DLP

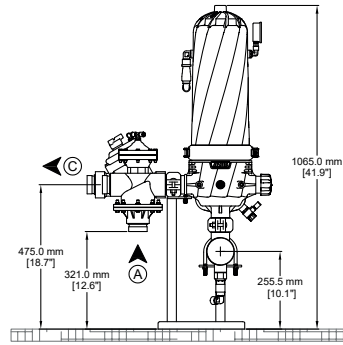
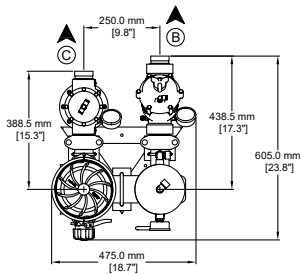

(A) 2" Inlet manifold (B) 2" Outlet manifold (C) 2" Drainage manifold

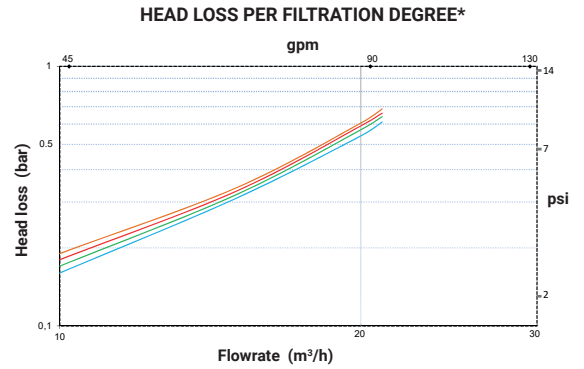

FT202 AA DLP

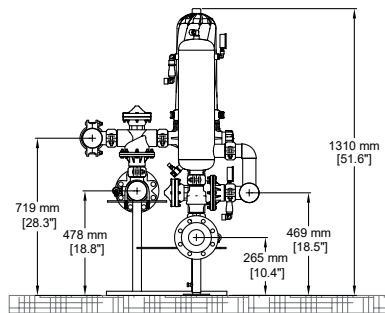
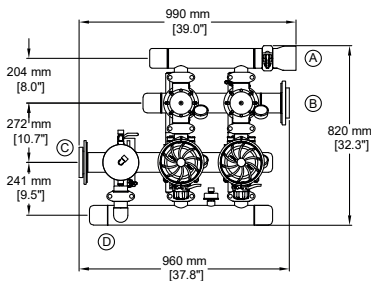

(A) 3" Drainage manifold (B) 3" Inlet manifold (C) 3" Outlet manifold (D) Inlet pressure manifold

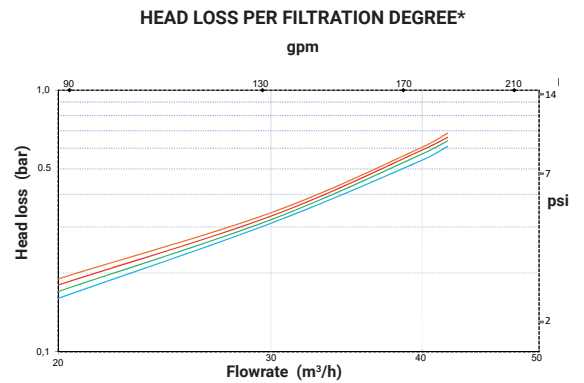

FT203 AA DLP

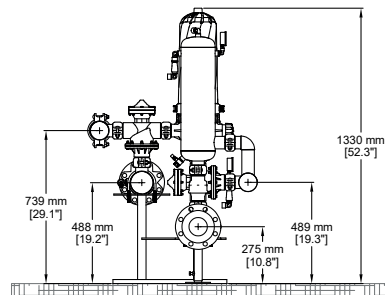
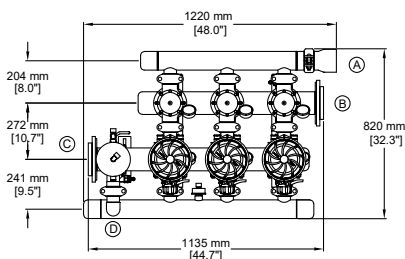

(A) 3" Drainage manifold (B) 4" Inlet manifold (C) 4" Outlet manifold (D) Inlet pressure manifold

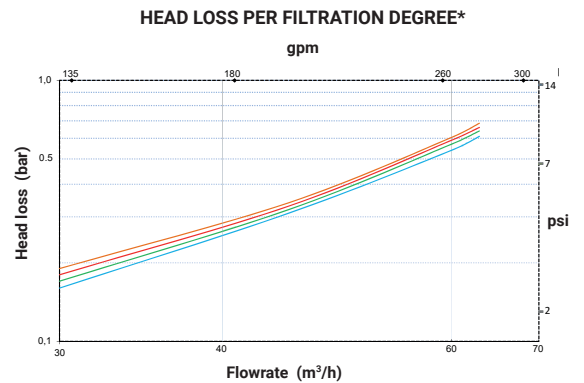

*The backwash frequency depends on the design flowrate. For hydraulic calculation, consider the set-point value for the self-cleaning cycle (usually 0.5 bar/7.25 psi).

MICRON **100** **130** **200** **400**

FT204 AA DLP

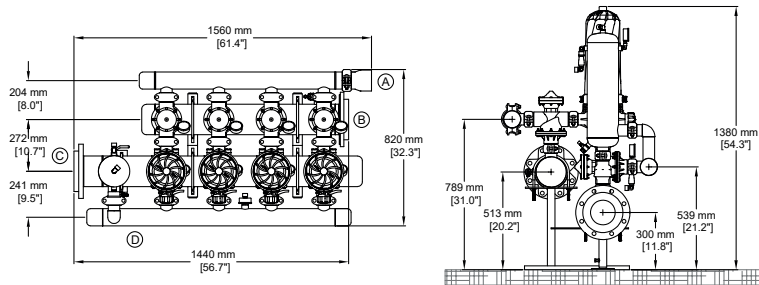

(A) 3" Drainage manifold (B) 6" Inlet manifold (C) 6" Outlet manifold (D) Inlet pressure manifold

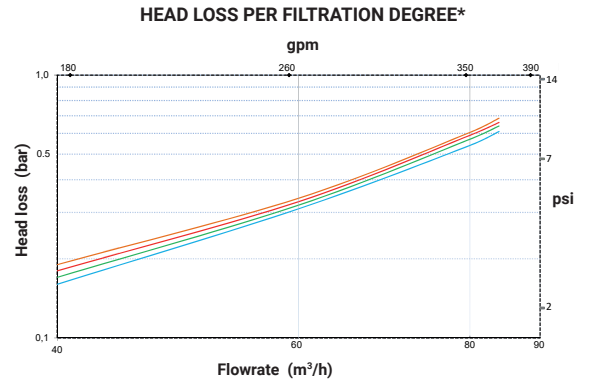

FT205 AA DLP

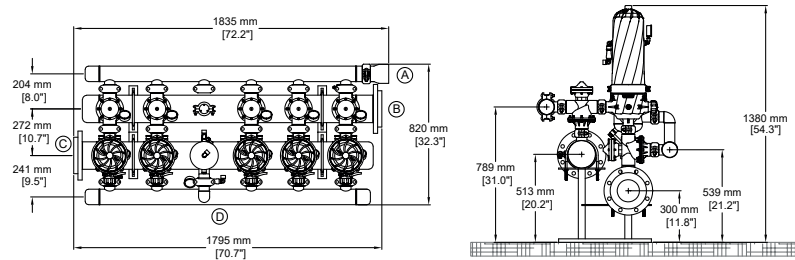

(A) 3" Drainage manifold (B) 6" Inlet manifold (C) 6" Outlet manifold (D) Inlet pressure manifold

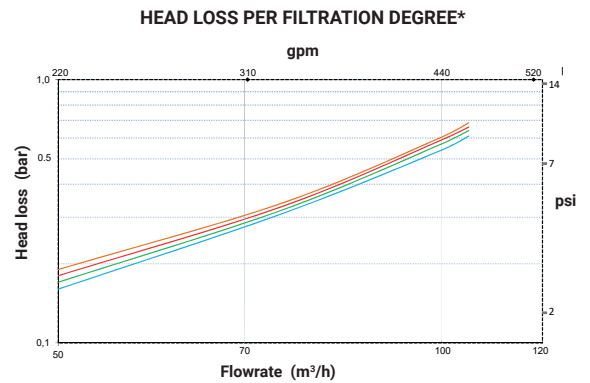

FT206 AA DLP

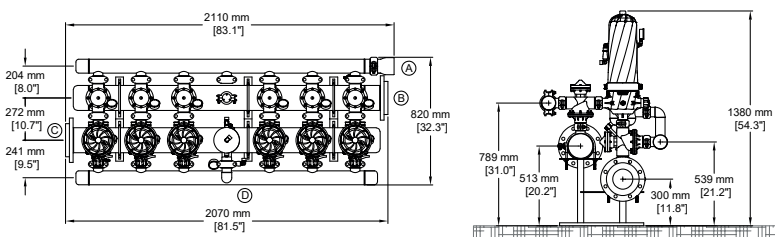

(A) 3" Drainage manifold (B) 6" Inlet manifold (C) 6" Outlet manifold (D) Inlet pressure manifold

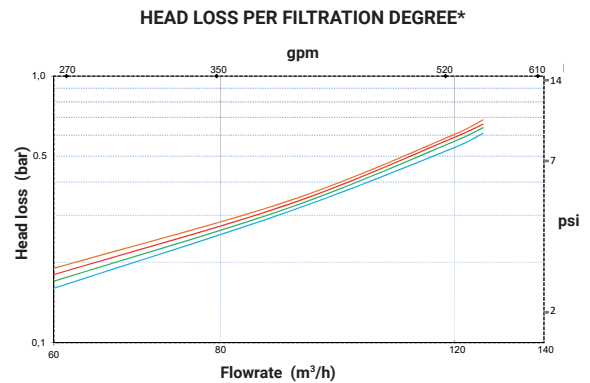

*The backwash frequency depends on the design flowrate. For hydraulic calculation, consider the set-point value for the self-cleaning cycle (usually 0.5 bar/7.25 psi).

MICRON 100 130 200 400

FT207 AA DLP

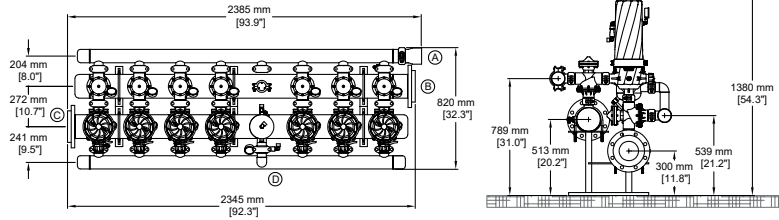

- (A) 3" Drainage manifold (B) 6" Inlet manifold (C) 6" Outlet manifold (D) Inlet pressure manifold

HEAD LOSS PER FILTRATION DEGREE*

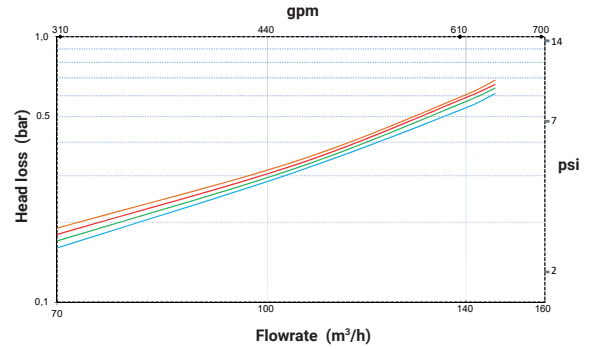

FT208 AA DLP

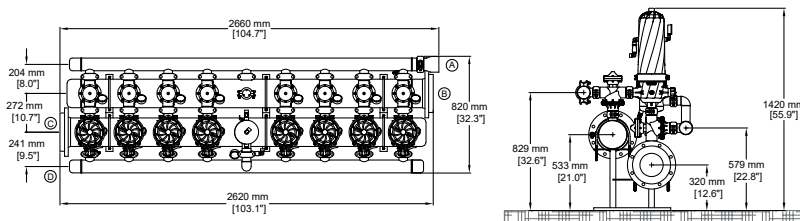

- (A) 3" Drainage manifold (B) 8" Inlet manifold (C) 8" Outlet manifold (D) Inlet pressure manifold

HEAD LOSS PER FILTRATION DEGREE*

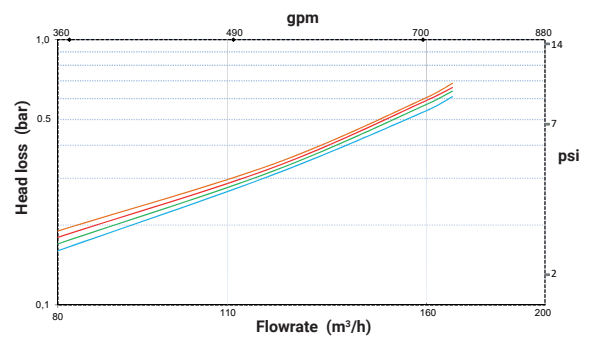

*The backwash frequency depends on the design flowrate. For hydraulic calculation, consider the set-point value for the self-cleaning cycle (usually 0.5 bar/7.25 psi).

! ASK FOR OUR EQUIPMENT UP TO 12 FILTERS



AZUD

EN EL MUNDO

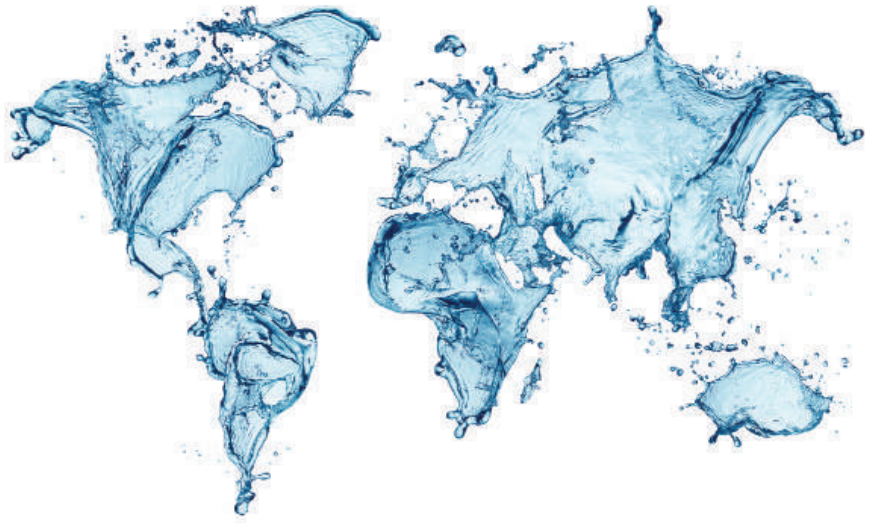

BELARUS



BRASIL



ARAB EMIRATES



MEXICO



QATAR



SOUTH AFRICA



CHINA



SOUTH KOREA

Avda. de las Américas P. 6/6 • Polígono Industrial Oeste
30820 Alcantarilla • Murcia - Spain • Apdo. 147 • 30169 San Ginés • Murcia - Spain
Tel.: +34 968 808 402 • Fax.: +34 968 808 302 • E-mail: info@azud.com • www.azud.com

